



ASCENSORE OLEODINAMICO INDIRETTO



PORTATA 480 - 6 PERSONE

PORTE DA 900 CENTRALI

DISEGNO DI
DISPOSIZIONE

6.90.2C.H

IMPIANTO AUTOMATICO

VELOCITA' MAX 1 mt/s

FOSSA 1200 mm

TESTATA 3400 mm

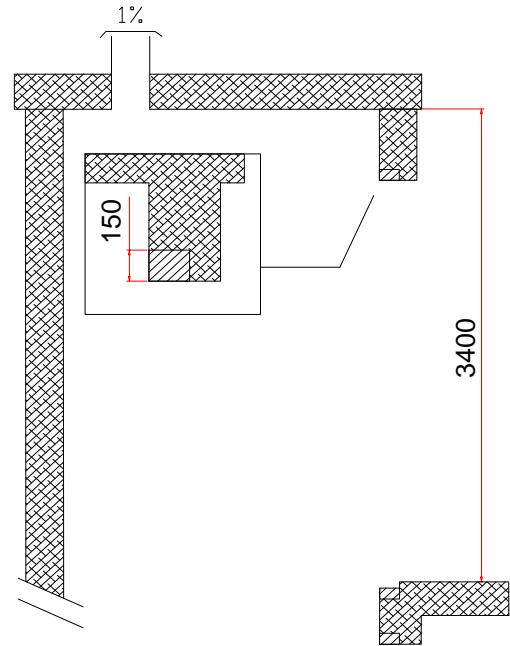
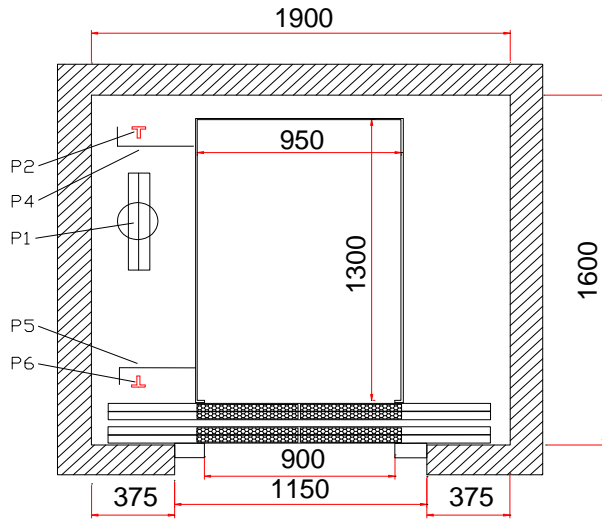

PER INGRESSI OPPOSTI PROFONDITA'

VANO MINIMO 1760

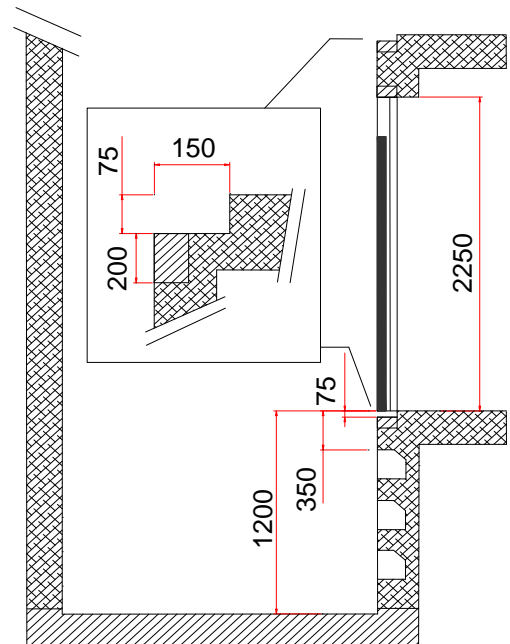

CARICHI

- P1 = 3950 Kg IN FOSSA IN CORRISPONDENZA DEL PISTONE
 - P2 = 1750 Kg
 - P6 = 1750 Kg
 - P4 = 1650 Kg
 - P5 = 1650 Kg
- IN CORRISPONDENZA DELLE GUIDE DI CABINA
- IN CORRISPONDENZA DEGLI AMMORTIZZATORI

REVISIONI

10/02/2006 - D.L.